

HM-Signal-2 规格书 (信号滤波器)

◆ 技术参数 Specification

额定电压 Rated voltage	250VAC
额定电流 Rated current	2A
线数 Line Quantity	2
气候类别 Climatic category	25/070/21

典型插入损耗 Typical insertion loss

频率	100K-18GHz
插入损耗 (dB)	≥100dB
共模、差模	

◆ 外形尺寸 Dimension

Outline Drawing and Dimensions: (mm)

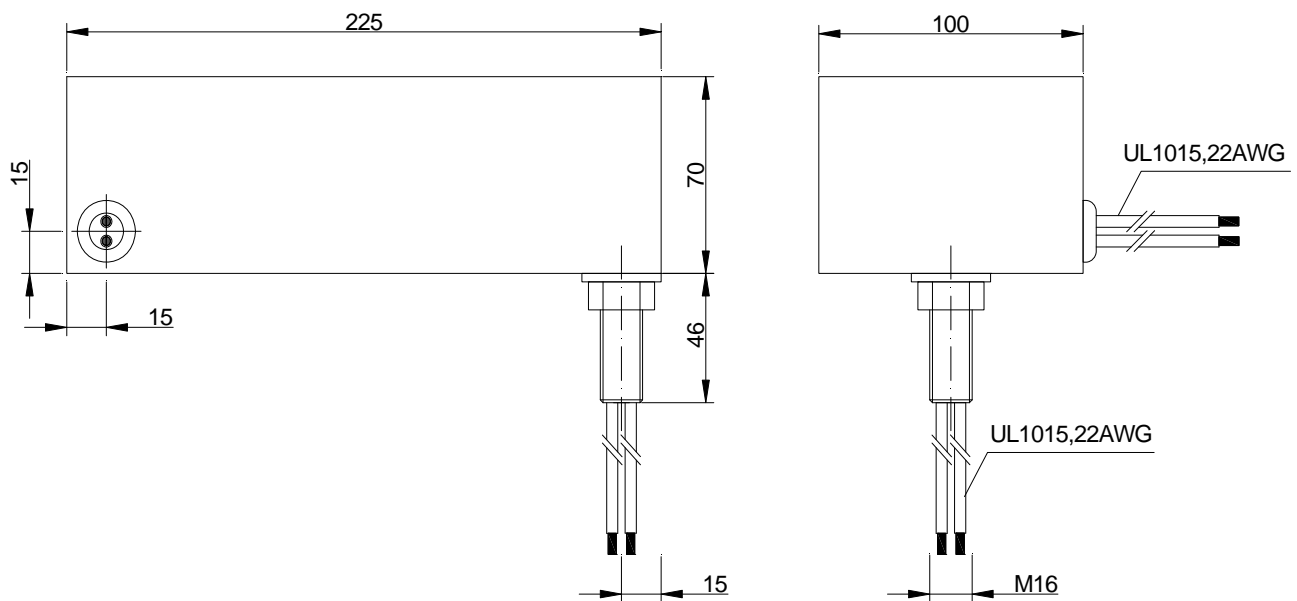

◆ 特点与应用 Features & Applications

工作频带宽，插入损耗高: Wide operating band, high insert loss

干扰抑制能力强: Strong ability for restrain interference

低压降，中等漏电流: Low voltage drop, low leakage current

用于电磁屏蔽房、屏蔽柜、电子方舱、信息安全保密房、医院 CT、核磁共振房、可控硅变流设备、电源净化设备的电源端的滤波 Use for filter in electro-magnetic shielding room、shielding cabinet、electronic、square cabin、information security room、CT equipment of hospital、nuclear-magnetic、resonance room、SCR current converting equipment、power terminal of the equipment for power purification.